

PLAN

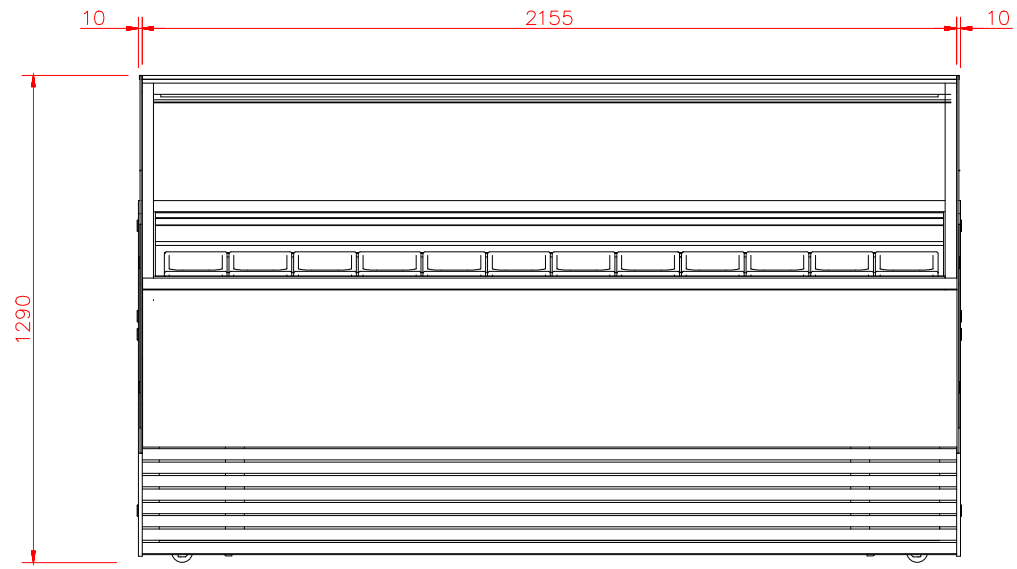

FRONT ELEVATION

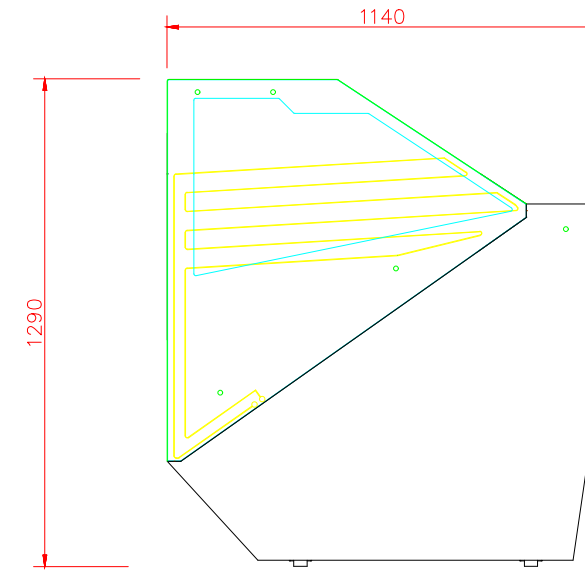

SIDE ELEVATION

OBJECT	NEO 24 G	DESIGN	Tugba KAPLAN Dip.Ing.Arch.
SCALE	1/20	DATE	02.03.2021