

LIME PLUS 5 R

Ref: 1



(Mod. R)

Ref: 2

Temperature range/Range di temperatura +4/+8° C

Doors, drawers/porte, cassetti

Static cold top units H= 30 mm with rounded bottom and drain hole to ease the condensation water discharge for a perfect cleaning and hygiene. These models are conceived to display ready meals, single portioned dessert and generally food displayed on trays or pans. Models for 2, 3, 4, 5, 6 GN1 /1 trays (trays are not included). Units are provided with condensing unit or ready for remote connection (R). Optional: overstructure with LED lighting.

Piani refrigerati statici H 30 mm con fondo arrotondato per agevolare lo scarico dell'acqua per una perfetta pulizia ed igiene. Modelli adatti all'esposizione temporanea di piatti pronti, dessert monoporzioni ed in generale alimenti adagiati su teglie piane e vassoi. Modelli per 2, 3, 4, 5, 6 vassoi GN 1/1 (non compresi). Versioni con gruppo incorporato o predisposte per connessione remota (R). Opzionale: sovrastrutture con illuminazione a LED.

Maximum Shelves N°/ Max Ripiani N°:

Maximum Pans N°/ Max Vaschette N°: 5 GN 1/1

All specifications are subject to change without notice. *Dati tecnici soggetti a modifiche senza preavviso.*

The Picture (Ref: 1), the description (Ref: 2) and the technical drawing (Ref: 5) refer to the product range. Dimensional Data (Ref: 3) and Technical Data (Ref: 4) refer to the specific code (Ref: 6).

L'immagine (Ref: 1), la descrizione (Ref: 2) e il disegno tecnico (Ref: 5) sono relativi alla famiglia prodotto. Dati di dimensione (Ref: 3) e Dati Tecnici (Ref: 4) sono specifici del codice indicato (Ref: 6).

Afinox s.r.l. via Venezia 4 - 35010 - Campo San Martino - Padova (PD) - ITALY - Tel. +39 0499638311 / e-mail: comm@afinox.com / web: www.afinox.com

Ref: 6 **Code/Codice 7DRLI5FR00A01**

Pag. 1 / 3

Rev.: **1 / 2018**

Dimensional Data/Dati di dimensione:

Ref: 3

External dimensions (mm) WxDxH <i>Dimensioni Esterne (mm) LxPxH</i>	1819x650x100	Insulation Thickness (mm) <i>Spessore di isolamento (mm)</i>	40
Internal Dimensions (mm) WxDxH <i>Dimensioni interne (mm) LxPxH</i>		Internal Volume (l) <i>Volume Interno (l)</i>	
Packing Dimensions (mm) WxDxH <i>Dimensioni Imballo (mm) LxPxH</i>	1883x714x1100	Gross Weight (Kg) <i>Peso Lordo (Kg)</i>	53
		Net Weight (Kg) <i>Peso Netto (Kg)</i>	44

Technical Data/Dati Tecnici:

Ref: 4

Power supply (V/Ph/Hz) <i>Alimentazione (V/P/Hz)</i>	230 / 1 / 50	Noise (db) 5m <i>Rumore (db) 5m</i>	
Yearly Energy Consumption (kWh/annum) <i>Consumo energetico Annuo (kWh/annum)</i>		Daily energy consumption (kWh/24h) <i>Consumo energetico 24H (kWh)</i>	
Nominal power consumption (W) <i>Potenza assorbita (W)</i>		Maximum absorbed current (A) <i>Massima corrente assorbita (A)</i>	
Energy efficiency class <i>Classe Energetica</i>		Climatic Class <i>Classe Climatica</i>	3 (25°C - 60%)
Blast chilling yield (Kg) *** <i>Resa Abbattimento (Kg) ***</i>		Refrigerating power (W) <i>Potenza Frigorifera (W)</i>	522**
Shock freezing yield (Kg) *** <i>Resa Surgelazione (Kg) ***</i>		Gas	
Compressor/ <i>Compressore</i>		Controller	EVX

* (-30/+45° C), ** (-10/+45° C)

Hood/Sovrastruttura

*** The blast chilling & shock freezing yields, expressed in Kg or lb are indicative and not binding. The food cooling time depends on its composition and sizing. The actual cooling time for various food might be different from the indicated one.

*** Le rese in abbattimento e in surgelazione espresse in Kg o lb sono indicative e non vincolanti. Il tempo di raffreddamento degli alimenti dipende dalla loro composizione e dimensione. Il tempo di raffreddamento reale dei vari alimenti, potrebbe essere diverso da quello indicato.

All specifications are subject to change without notice. *Dati tecnici soggetti a modifiche senza preavviso.*

The Picture (Ref: 1), the description (Ref: 2) and the technical drawing (Ref: 5) refer to the product range. Dimensional Data (Ref: 3) and Technical Data (Ref: 4) refer to the specific code (Ref: 6).

L'immagine (Ref: 1), la descrizione (Ref: 2) e il disegno tecnico (Ref: 5) sono relativi alla famiglia prodotto. Dati di dimensione (Ref: 3) e Dati Tecnici (Ref: 4) sono specifici del codice indicato (Ref: 6).

Afinox s.r.l. via Venezia 4 - 35010 - Campo San Martino - Padova (PD) - ITALY - Tel. +39 0499638311 / e-mail: comm@afinox.com / web: www.afinox.com

Ref: 6 Code/Codice 7DRLI5FR00A01

Pag. 2 / 3

Rev.: 1 / 2018

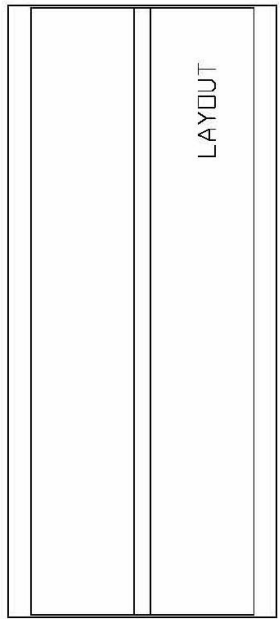
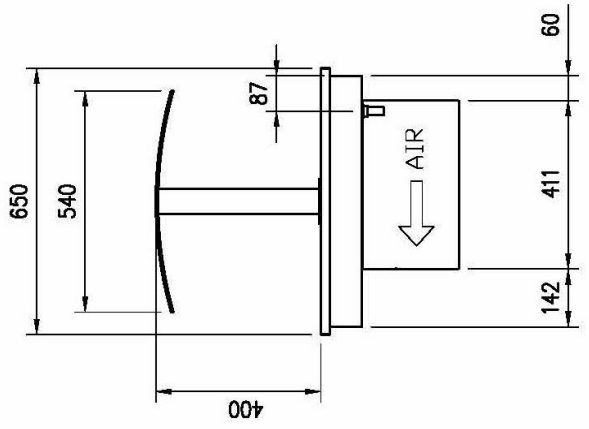
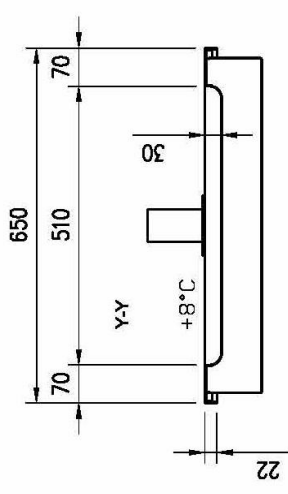
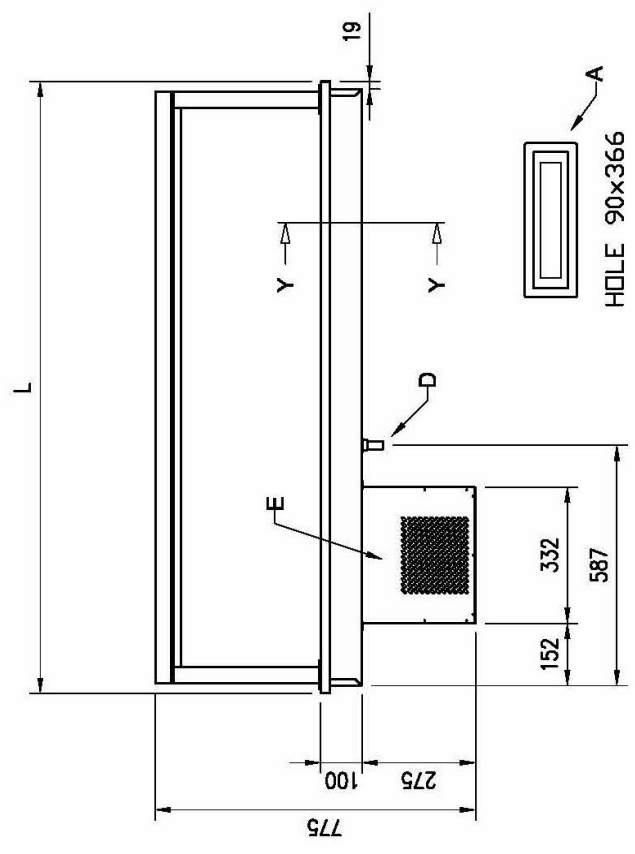
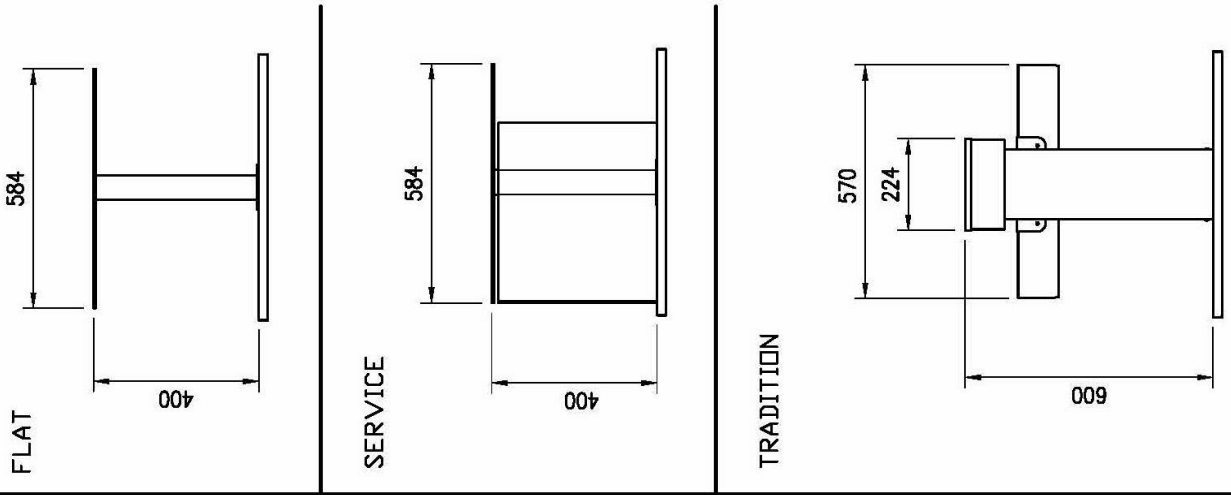

GN	L	HOLE
2/1	844	814x620
3/1	1169	1139x620
4/1	1494	1464x620
5/1	1819	1789x620
6/1	2144	2114x620

A= ELECTRICAL CONNECTION
 D= WATER DISCHARGE ø16
 E= GAS CONNECTION ø6 ø8
 F= WATER BOX

All specifications are subject to change without notice. *Dati tecnici soggetti a modifiche senza preavviso.*

The Picture (Ref: 1), the description (Ref: 2) and the technical drawing (Ref: 5) refer to the product range. Dimensional Data (Ref: 3) and Technical Data (Ref: 4) refer to the specific code (Ref: 6).

L'immagine (Ref: 1), la descrizione (Ref: 2) e il disegno tecnico (Ref: 5) sono relativi alla famiglia prodotto. Dati di dimensione (Ref: 3) e Dati Tecnici (Ref: 4) sono specifici del codice indicato (Ref: 6).

Afinox s.r.l. via Venezia 4 - 35010 - Campo San Martino - Padova (PD) - ITALY - Tel. +39 0499638311 / e-mail: comm@afinox.com / web: www.afinox.com