



SBP-120



SBP-170



SBP-220



SBIEP-120



SBIEP-170



SBIEP-220

mod.	rango range	largo length (mm)	alto height (mm)	fondo depth (mm)	potencia frig. frig. power (W)	capacidad latas cans capacity 33 cl.	capacidad litros litres capacity	estantes shelves	puertas abatibles hinged doors
SBEP/SBIEP-120	+2°C+8°C	1165	820 / 880	530	485	320	325	4	2
SBEP/SBIEP-170	+2°C+8°C	1705	820 / 880	530	485	500	490	6	3
SBEP/SBIEP-220	+2°C+8°C	2245	820 / 880	530	485	680	650	8	4

Características técnicas y constructivas sujetas a variación sin previo aviso.

We reserve the right to change specifications without prior notice.

SBEP

- Exterior en acero plastificado negro
- Interior en acero plastificado gris

SBIEP

- Exterior en acero inoxidable
- Interior en acero plastificado gris

CARACTERISTICAS COMUNES

- Diseñados para bebidas y productos envasados
- Doble cristal sobre marco abatible
- Estantes de alambre de acero plastificado, regulables en altura
- Evaporador sistema tiro forzado, con recubrimiento epoxi anticorrosión
- Control digital de temperatura, descarches optimizados, alarma por alta temperatura de condensación. Eficiente gestión del consumo de energía
- Iluminación interior LEDs
- Aislamiento de poliuretano inyectado, densidad 40 Kg/m³, bajo GWP y cero efecto ODP
- Pies regulables, con suplemento para altura 880 mm (incluido)
- Temperatura de trabajo a 32°C ambiente
- Tensión monofásica 230V - 50Hz
- Unidad condensadora **NO INCLUIDA**, refrigerante recomendado R134a
- Control de expansión de refrigerante **NO INCLUIDO**
- Rendimiento del evaporador con $\Delta t=12^{\circ}\text{C}$
- Evaporación automática **opcional**
- Válvula de expansión, **opcional**

SBEP

- Anthracite plastic coated steel exterior
- Interior gray plastic coated steel

SBIEP

- Stainless steel exterior
- Interior gray plastic coated steel

FEATURES IN COMMON

- Designed for beverages and packaged products
- Double glass on folding frame
- Steel wire shelves adjustable plastic height
- Forced draft evaporator system with anticorrosion coating
- Digital temperature control, optimized defrost, high-temperature condensation alarm. Efficient management of energy consumption
- LEDs interior lighting
- Isolation of polyurethane, density 40 Kg / m³, zero ODP and GWP
- Adjustable feet, with suplement for height 880 mm (included)
- Operating temperature 32°C ambient
- Voltage 230V - 50Hz
- Condenser unit **NOT INCLUDED**, recommended coolant R134a
- Refrigerant expansion control, **NOT INCLUDED**
- Performance of the evaporator with $\Delta t = 12^{\circ}\text{C}$
- **Optional** automatic evaporation of defrost water
- Expansion valve, **on demand**

BAR EQUIPMENT • EQUIPAMIENTO PARA BARES

Opciones - Options

Cajonera doble INOX	Stainless Steel double drawers set
Cajonera doble plast. negro	Black plastic coated double drawers set
Cajonera triple INOX	Stainless Steel triple drawers set
Cajonera triple plast. negro	Black plastic coated triple drawers set
evaporación automática	automatic evaporation
válvula de expansión	expansion valve
230v 60Hz / 115v 60Hz	230v 60Hz / 115v 60Hz
cambio a estante chapa inox	SS panel shelve increase

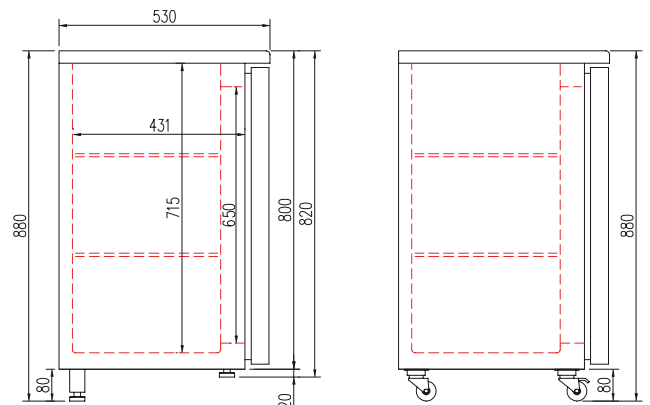

all photos must be considered as a reference - fotografías no contractuales



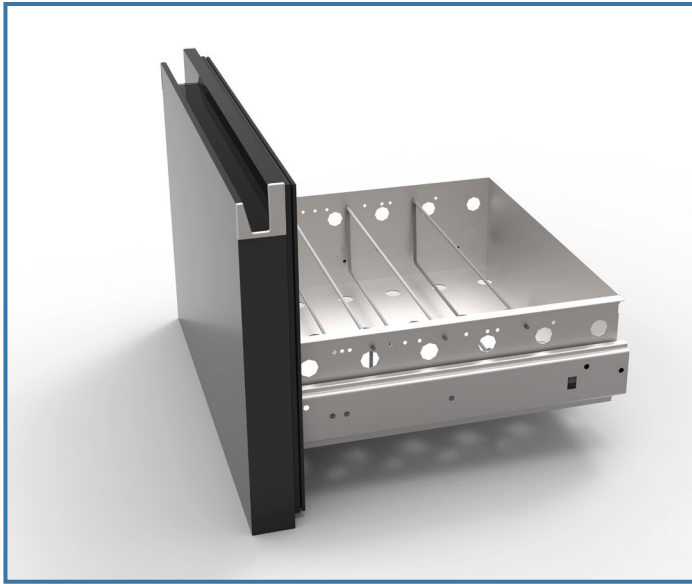

Características técnicas - Technical data

- Exterior en acero plastificado negro o acero inoxidable AISI-304
 - Cuerpo interior en acero inoxidable AISI-304
 - Guías telescópicas AISI-304, desmontables con pestillo de seguridad
 - Capacidad de carga dinámica 65 Kg.
 - Tirador ergonómico, de fácil limpieza
 - Separadores interiores adaptables a diferentes medidas
 - Set de cajones, intercambiables con puertas
-
- Anthracite plastic coated or AISI-304 Stainless steel
 - Internal structure in AISI-304 Stainless steel
 - AISI-304, detachable runners with security click
 - Dynamic load capacity 65 Kg.
 - Ergonomic handle, easy to clean
 - Adaptable internal dividers
 - Doors and drawers sets are interchangeable

Capacidad latas y botellas - Cans and bottles capacity

ø 53 mm

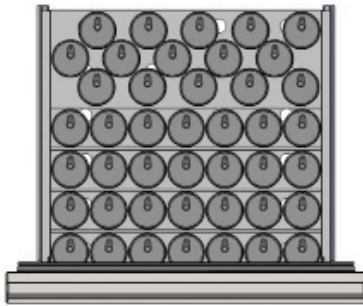

ø 60 mm

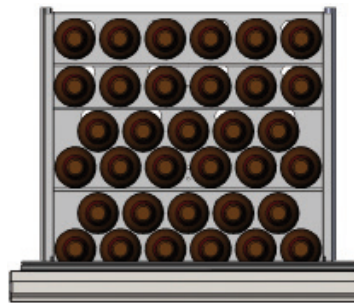

ø 66 mm

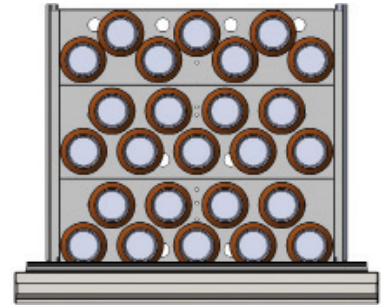

ø 70 mm

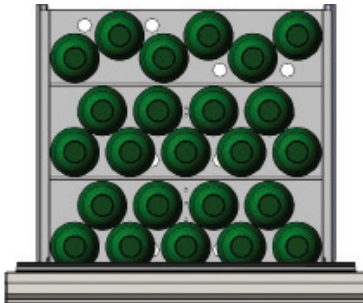

ø 80 mm

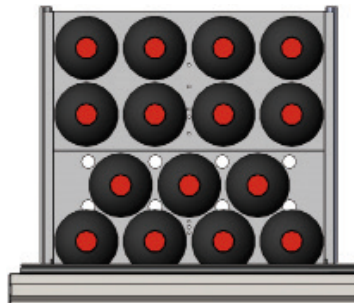

ø 105 mm

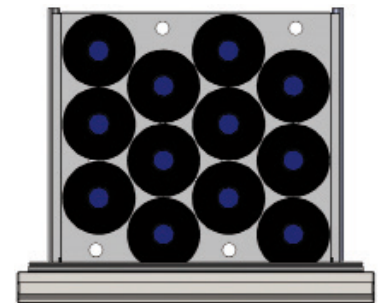

Altura cajones - Drawers height

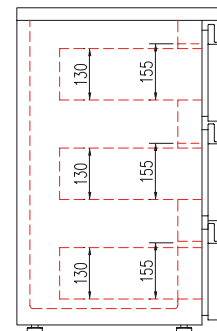
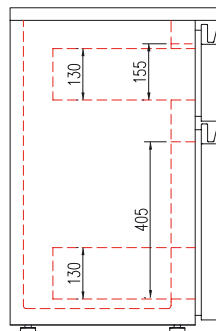
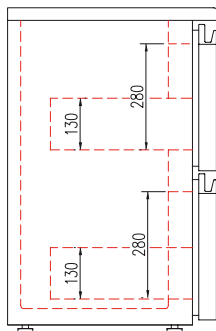

all photos must be considered as a reference - fotografías no contractuales

